

Industry 4.0 – Applications in Practice

Even though industry 4.0 is often referred to as the blueprint for the future factory, intelligent applications that enable a customizable and highly flexible production, are long since reality.



Serialization of medicine packs

- User benefits: Piracy protection and traceability from production to the drug store
- Medicine packs are provided with UHF-RFID tags and tracked throughout the entire logistics process
- Machines for bulk reading of up to 500 tags in a closed box
- Data consistently available in cloud storage



Control of chocolate production via the molds

- User benefits: Mixed production of different products depending on the casting mold
- RFID data carriers in each casting mold control the production process
- Fast and unproblematic product changes in flexible systems
- Automatic selection of casting and mold washing program



Automated 100% quality control in automotive production

- User benefits: Cost reduction and increased customer satisfaction through fully automated process control
- Reliable 100% single piece inspection according to leaks, excluding manual error sources
- RFID sensor tags detect moisture that has penetrated after passing through the irrigation chamber
- Measurement data is recorded in the MES and evaluated in order to optimize production processes



Identification of bumpers

- User benefits: Traceability from production to the end customer, optimized production control between suppliers and carmakers
- Bumpers can be identified with RFID tags through the entire production and logistics process
- RFID tag contains all information for controlling the processing machines via OPC server
- Integration of the collected data in ERP and WMS systems



Identification of Cryovessels in the pharmaceutical industry

- User benefits: Avoidance of allocation errors through reliable product identification across multiple sites
- Cryovessels allow clear identification of the container and contents with RFID tags
- Reliable and secure identification even with inaccurate positioned container by 400 mm read/write heads
- Data reconciliation between international locations via cloud



Position detection of the gondola arms in circular rides

- User benefits: Cost reduction, simple central parameterization via I/O-link, as well as increased operational reliability and availability
- Contactless operating linear position sensors with IO-link detect the horizontal location of the gondola arms of a fairground ride.
- Increased plant availability by prefailure warning on the linear position sensor
- Cost savings in wiring and construction

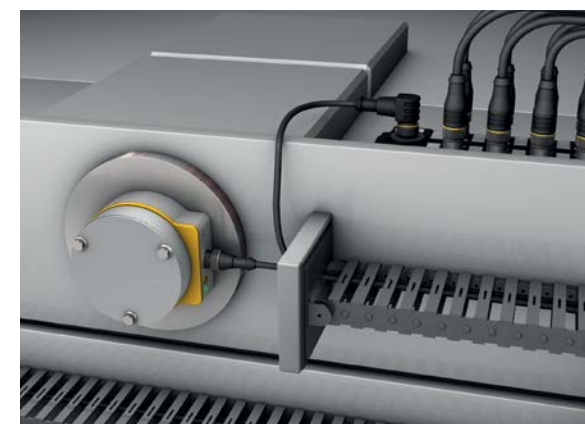

Capturing the swivel movement of a core box girder

- User benefits: Higher machine availability through IO-Link diagnostic functions
- QR24-IO-Link encoder registers the swivel movement of the core box girder in a core shooting machine
- Integrated IO-Link automation of the machine replaces expensive fieldbus solution and allows simple error diagnostics
- Reduction of mechanical breakdowns of the encoder and continuous monitoring of the resonator position

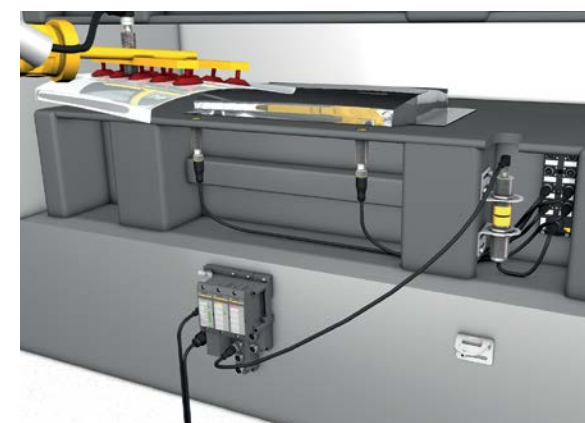

Format changes on presses in the automobile production

- User benefits: Reduced changeover times by automated changing of molds during the process
- New pressing tools are identified contactless by NIC couplers and TBIL-I/O-hub via IO-Link (Application Specific tag)
- Reduced standstill due to wear-free energy and data transmission
- Inductive coupling for contactless transmission of necessary information and energy

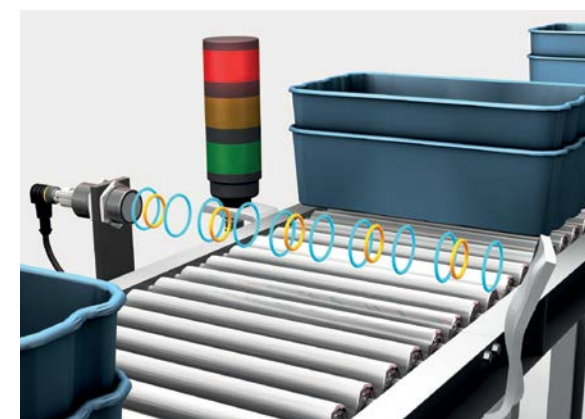

Preventive maintenance of conveyor belts

- User benefits: Increased plant availability through prefailure warning
- Ultrasonic sensor with IO-Link continuously monitors the flow of the conveyed goods
- Signal quality of the sensor indicates whether a severe fault exists or is imminent, as for example a bent or torn-off reflector
- Temperature fluctuations of the ambient are compensated directly thanks to integrated temperature sensor



Monitoring of cabinets and protective housings

- User benefits: Increased plant availability and avoidance of unplanned downtimes
- CCM Cabinet guard continuously monitors correct door closing, temperature and humidity in control cabinets and protective housings - also in hazardous areas
- On exceedance of limits, a signal to higher-level systems is automatically issued
- Data logger captures also gradual changes, such as porous seals

Your Global Automation Partner

Industry 4.0 Data and Communication Solutions



28 subsidiaries and over
60 representations worldwide!



Industry 4.0 – User Benefits

- Increased availability of machines and plants
 - Condition Monitoring allows preventive maintenance without unplanned outages, required spare parts can be planned and ordered in time
- Better quality assurance up to the end user
 - Automated quality assurance processes reduce erroneous deliveries
 - Data acquisition and processing guarantee at any time traceability or optimized production processes
- More efficient production in small quantities
 - Faster changeover times for new product versions, realized by sensors that receive their new identity/function through a main control
 - Increased efficiency through interdisciplinary communication, if e.g. information on capabilities is directly transferred to production planning.
 - Energy efficiency through better utilization and fewer rejects thanks to optimized production

Turck supports you on the way to industry 4.0 with innovative solutions for the detection, processing, and transmission of relevant production data

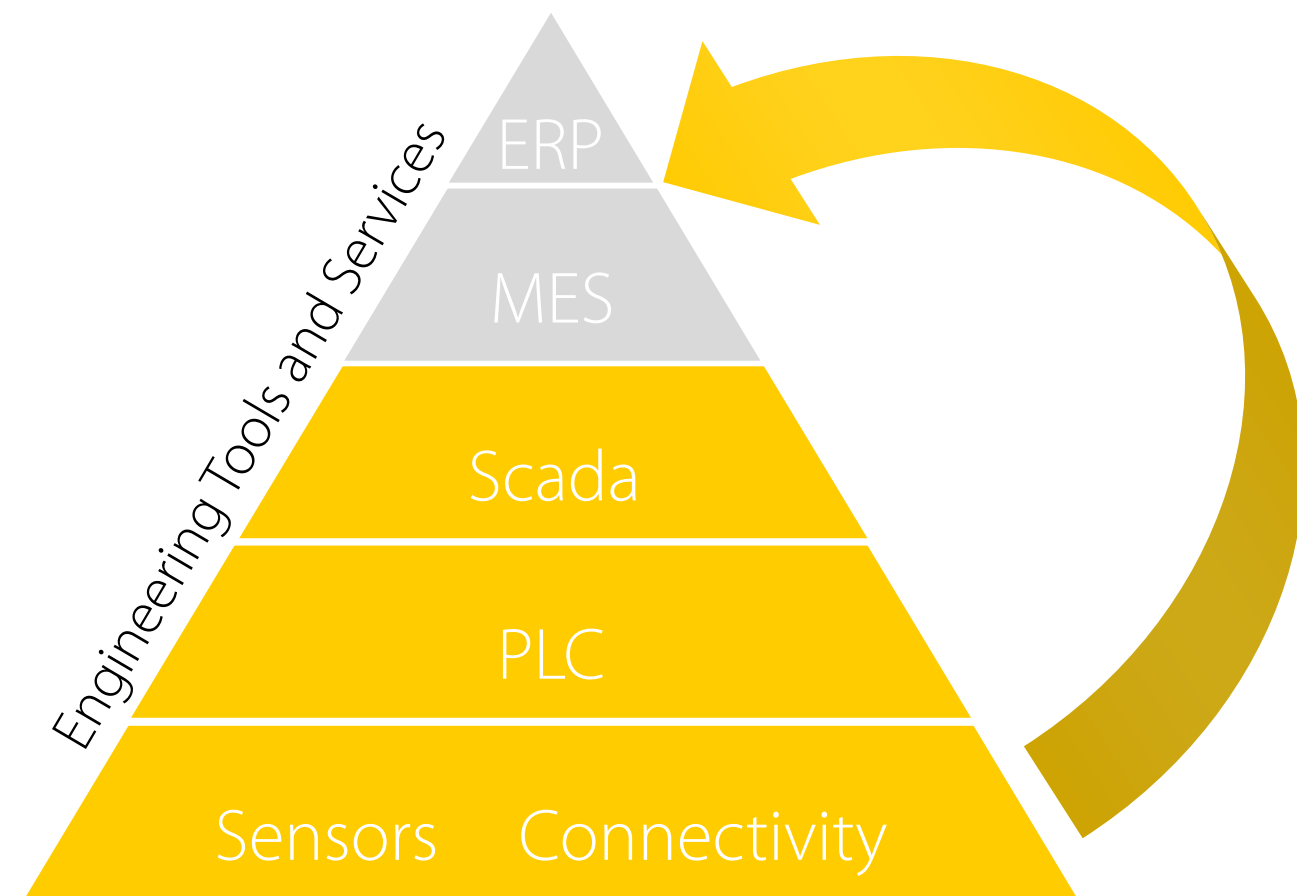

Industry 4.0 – Key Technologies

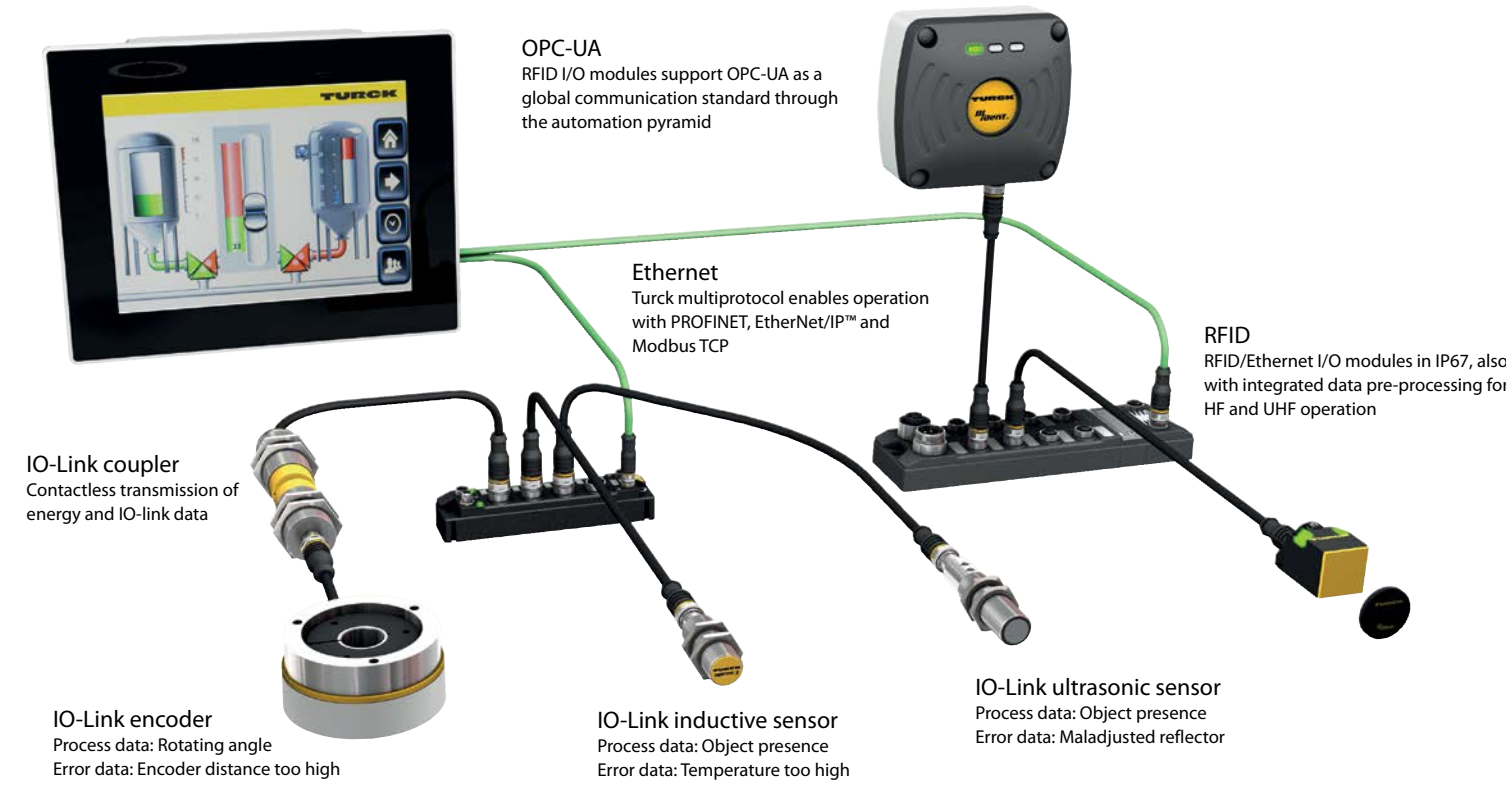

Whether RFID, IO-link, OPC-UA or Ethernet – as a specialist in the key technologies of industry 4.0 Turck paves the way to the intelligent future factory for you.

RFID

With the RFID system BL ident Turck has implemented solutions for flexible control of production processes, but also for the spare parts/service business, piracy protection or serialization. Together with the IP67 I/O PLC modules from Turck you have available robust solutions with distributed intelligence for data processing or for control tasks.

IO-Link

Turck offers one of the most comprehensive portfolios of IO-Link solutions - ranging from numerous sensors and connection technology to fieldbus and Ethernet I/O systems with IO-Link masters in the protection classes IP20 and I67. How to benefit from intelligent data acquisition and communication solutions from a single source.

OPC-UA

OPC-UA is the world's next standard for integrative communication across all levels of the automation pyramid. In close cooperation with science and industry, Turck participated in the development of the standard and has already implemented it in the first products.

Ethernet

Ethernet is the standard for communication, not only in the IT world, but also in the industrial environment. Turck offers especially user-friendly solutions such as the multiprotocol technology that supports the automatic use of I/O systems in the Ethernet protocols PROFINET, Modbus TCP or EtherNet/IP™.

Industry 4.0 – Data and Communication Solutions



- TX500/TBEN-PLC – HMI and block I/Os with CODESYS 3 PLC
- User benefits: Distributed intelligence with simple integration for control tasks directly on the machine or plant
 - Flexible use as a PROFINET controller, EtherNet/IP™ scanner or Modbus TCP master – in addition CANopen, Modbus RTU and RS232/485
 - TX500: Modern HMI/PLC compact units for easy programming of control and visualization functions with CODESYS 3
 - TBEN-L-PLC: Rugged IP67 block I/Os with CODESYS-3 PLC for intelligent control concepts without cabinet



- TBEN-DCC – RFID module with integrated middleware
- User benefits: Direct communication with higher-level ERP or MES systems via Ethernet TCP/IP
 - Rugged I/O block module in IP67 with Windows Embedded Compact 2013
 - Four RFID read/write heads in HF or UHF technology and further eight user-definable digital inputs/outputs available
 - Management and control of hardware, data filtering and pre-processing with integrated middleware component "Device Control Service"



- ARGEE – PLC functionality for multiprotocol I/O modules
- User benefits: Programming of basic functions without any knowledge of a programming language made simple
 - Browser-based ARGEE programming environment turns Turck's Ethernet block I/O series TBEN-L, TBEN-S, BL compact and FEN20 into compact PLCs
 - Simple controller functions can be outsourced to the I/O modules, thus relieving the workload on the central PLC and the bus communication
 - Data exchange with higher-level systems via PROFINET, EtherNet/IP™ or Modbus TCP

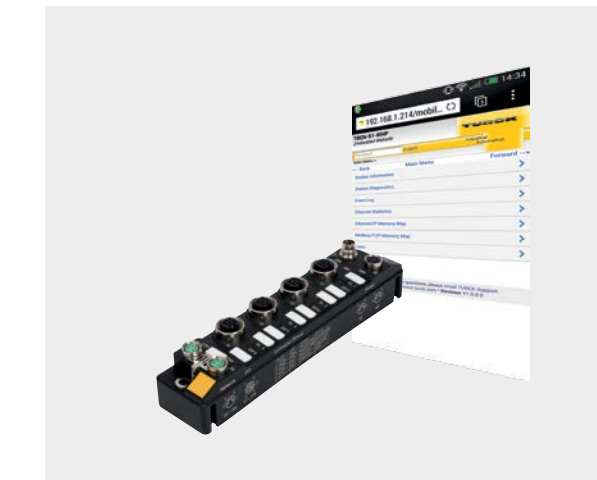

- TBEN – Multiprotocol Ethernet I/O solutions in IP67
- User benefits: Easy integration into systems and diagnostic functions via integrated web servers also on smartphones
 - Robust I/O block module with protection to IP67 in TBEN-L and TBEN-S (ultracompact) design
 - Can be used in any of the three Ethernet systems PROFINET, Modbus TCP or EtherNet/IP™
 - Turck multiprotocol technology detects the protocol used automatically by listening to the communication traffic during the startup phase

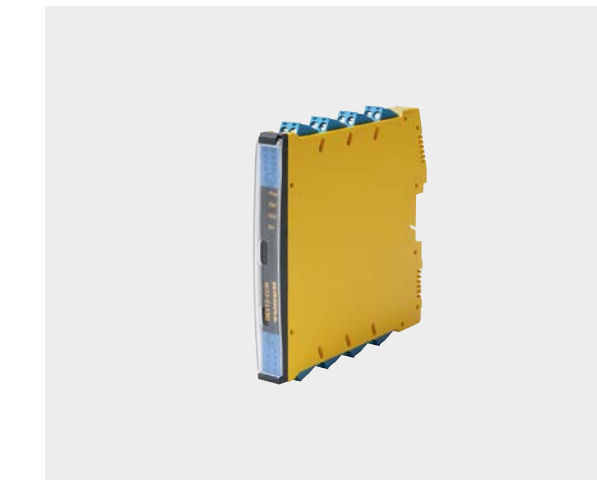

- IMX12-CCM – Condition monitoring for control cabinets
- User benefits: Recognizes potential sources of error for preventive maintenance, thus avoiding unplanned shutdowns
 - IMX12-CCM cabinet guard continuously monitors the relevant ambient variables inside control cabinets and protective enclosures
 - Reports incorrectly closed doors and limit value violations for temperature and internal humidity via a switch signal to control systems
 - Also detects creeping changes in the control cabinet



- Extensive IO-Link portfolio – Masters, couplers, hubs, sensors
- User benefits: Fast device replacement, flexible and reliable application through comprehensive configuration and diagnostic options
 - Turck offers one of the most comprehensive portfolios of IO-Link solutions – from a variety of sensors and cables and I/O hubs to programmable fieldbus and Ethernet solutions
 - Thanks to the "Application Specific Tag", unique identification without the use of additional hardware or barcodes is possible
 - Data Storage feature of IO-Link 1.1 offers a plug-and-play replacement of sensors