

Food and Beverage Solutions

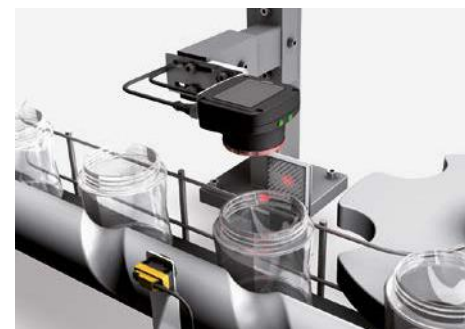

Identification of chocolate moulds

- The **RFID system BL ident®** reliably detects each and every chocolate mold and thus improves the efficiency of systems and quality of products
- Application-optimized data carriers and read/write heads for food and beverage applications



Container check

- The **vision sensor iVu** checks plastic and glass containers before they are filled and thus avoids rejects
- Easy teaching of the sensor without PC
- Removable display



Speed monitoring of conveyor belts

- The **contactless inductive encoder QR24** reliably detects the speed of a conveyor system for potatoes
- Fully encapsulated, resists therefore aggressive chemicals and high pressures during the cleaning process.
- Thanks to the contactless inductive principle insensitive to vibration of the motor axis

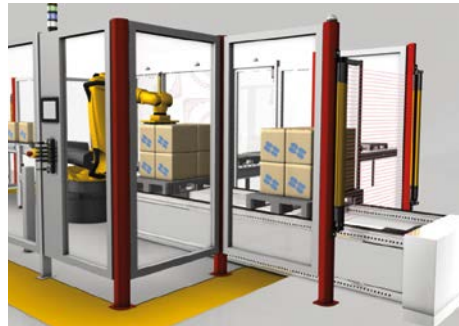

Efficient hazard zone guarding

- Machine safety through hybrid module with integrated safety logic
- Scalable safety levels up to SIL3, PLc
- Simple integration in high protection class through field-wirable cables

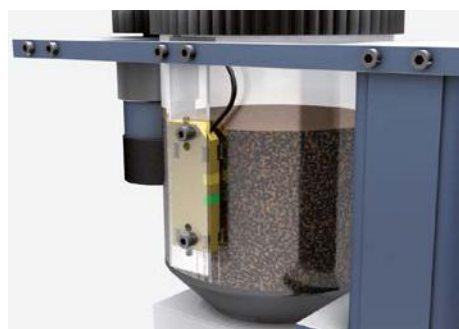

Level monitoring of ground coffee

- The **capacitive sensor QF5,5** reliably detects the level of ground coffee inside the container
- Easy integration into the machine design due to especially flat sensor form



Detecting pipe elbows

- The **inductive uprox®+ WD sensors** reliably detect pipe elbows at pipe manifolds and thus ensure high system availability
- Secure functioning thanks to extra-large switching distance for all metals, even with worn seals
- High tightness and resistance to chemicals

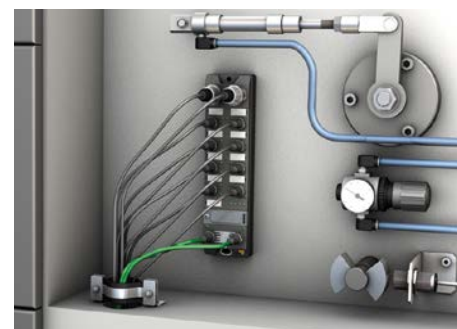

Reliable operation of machines

- Packaging machines are operated reliably thanks to the extremely rugged connection technology of the **block I/O fieldbus station TBEN**
- For many standard fieldbuses
- Multiple Ethernet protocols with the same module without replacement thanks to multiprotocol technology
- Cost-efficient due to cabinetless installation, withstands even aggressive cleaning processes



Identification of meat hooks

- The **RFID system BL ident®** reliably identifies meat hooks for efficient control and easy traceability of production processes.
- Flush mountable data carriers for unslotted hooks
- Read/write head Q42 in IP69K detects hooks in harsh production environments



Detects can feeding gaps

- The inductive sensor **Q130WD** monitors the gapless-feeding of food cans on the conveyor line and thus prevents production errors
- uprox®-1 technology enables large detection range and reliable detection of tinplate and aluminium cans
- Maximum mounting freedom in lateral guide rails
- Suitable for high-pressure cleaning thanks to protection class IP68/IP69K



Dough thickness control in rolling machines

- The **inductive linear position sensor LI** continuously checks the dough thickness to ensure consistent quality
- Contactless operating principle, therefore permanently high protection class and accuracy
- Absolutely wear-free

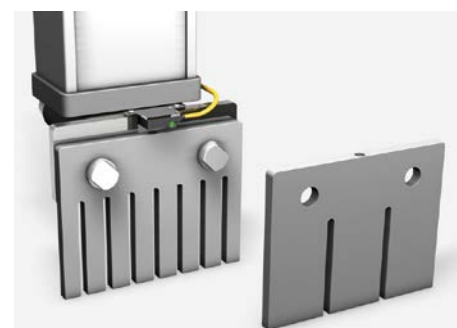

Monitoring changeover processes

- The **RFID system BL ident®** reliably identifies machine parts during changeover processes and thus reduces machine downtimes
- Application-optimized compact read/write heads
- Rugged miniature data carriers in a stainless steel housing, easily installed in machine parts



Your Global Automation Partner

Solutions for the Food and Beverage Industry



Over 30 subsidiaries and 60 representatives worldwide!

www.turck.com



Collect Precisely

Inductive uprox®+ and wash-down sensors

- Largest switching distances and factor 1 for all metals
- Extended temperature range, protection class IP68/69K
- Resistant against wet temperature shock tests (ice water – boiling water)
- Food-safe chemically resistant materials, Ecolab certified versions



Linear position and angle sensors

- Available in different sizes, max. 7,500 mm
- Analog level control with hygiene-compliant stainless steel floats
- Magnet-free resonator principle for interference-free detection of signals; works contactless, wear-free and permanently water-tight



Capacitive sensors

- Highly chemical-resistant housings and tank inserts
- Food-safe materials
- Teachable



Vision sensors iVu

- Compact image processing solution for inspection tasks and code reading
- Integrated or external display
- Taught and operated without PC



Magnetic field sensors

- Detect the piston position on pneumatic cylinders reliably



Ultrasonic sensors

- V4A metal-encased sensors for extremely harsh application conditions
- Protection class IP69K
- Compact sensors with teach function



Photoelectric sensors

- Improved tightness and resistance to chemicals
- Ecolab certified
- Detect filling levels with glass tip
- Safety light screens



Pressure, temperature, flow sensors

- Different designs, measuring principles, and process connections
- Easy handling and mounting
- Highest accuracy and safety

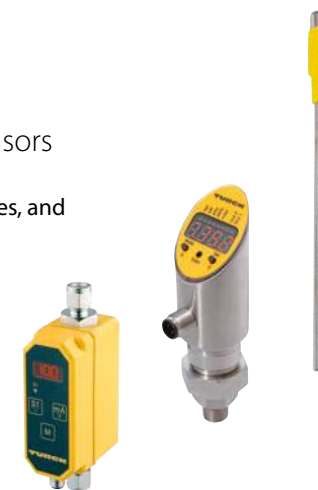

Connect Reliably

Cable and connectors

- Very tight and resistant to chemicals
- Food-safe materials
- Ecolab certified versions
- Resistant to wet temperature shocks (ice water –boiling water)



Passive junctions and T-pieces

- Signal transmission and voltage distribution
- Different designs and wirings



Interface and power supply modules

- Modules to isolate, convert, process and condition analog or digital signals for example temperature and rotation speed
- Different standard designs and widths
- Innovative accessories: Power supply modules, removable terminals, programming adapters
- Cabinet Guard IM12-CCM – perfect Protection of IP20 installation



Communicate Effectively

Compact I/O modules in IP67, IP69K and IP20

- Multiprotocol technology for PROFINET, EtherNet/IP™ and Modbus TCP
- Stainless steel flanges, for use in wet areas
- Fully potted (IP67, IP69K), vibration and shock tested
- Various designs with 4 to 16 I/O channels, Analog I/Os, temperature, RS232/RS485 and RFID interfaces
- Hybrid module for safety and standard I/Os
- Decentralized, pre-processing, fast logic thanks to Field Logic Controller (FLC) programmable with ARGEE



Modular I/O system BL67

- Gateways for many different fieldbuses and Ethernet, can also be programmed with CODESYS V3
- Multiprotocol technology for PROFINET, EtherNet/IP™ and Modbus TCP
- I/O modules available as: digital, analog, temperature, counter, RS232/485/422, SSI, CANopen, RFID, valve manifolds and IO-Link master
- Connectivity: M8, M12, M23 and 7/8"



DX wireless system

- Flexible network modules for radio transmission of sensor signals
- Point-to-point connection, star topology, Multi-Hop Repeater Network
- Configuration software



Automate Efficiently



Machine safety

- Protection of hazardous areas up to SIL3, Performance Level e
- Due to safe decentralized logic in the module, highly efficient safety technology even without safety bus protocol
- Hybrid I/O module Combinatorics of 8 safe I/Os and up to 36 standard I/Os thanks to IO-Link Master on board

HMI panel

- Programming of control and visualization functions with CODESYS 3
- HMIs with and without integrated PLC
- Flexible use as PROFINET, EtherNet/IP and Modbus TCP/RTU Master
- Brilliant TFT displays with screen diagonals from 4" to 15"



Decentralized control

- Fully-fledged control in IP67 with master or slave function, multiprotocol and multiple interfaces, edge gateway function
- CoDeSys V3 programmable gateways for I/O systems BL67 and BL20
- Modularly expandable with all available BL I/O modules
- Can also be used as fieldbus or Ethernet slave
- Highest flexibility due to a wide range of variants in the Ethernet communication

Pick-to-Light system

- Optical user guidance for manual assembly and commissioning processes
- Contactless pick-up alert
- Easily integrated in existing systems via the modular BL20 and BL67 I/O systems



Turck cloud solutions

- Functions such as monitoring, alarm, reports, trends and location information already integrated
- Simple and fast integration, also in existing architectures
- Secure hosting of the data in different variants such as private or public
- Increase of machine availability and added value through digitization

IO-Link

- Fieldbus-neutral communication standard for sensors and actuators
- Simple device configuration via control system or FDT/DTM
- IO-Link sensors, masters and IO-hub

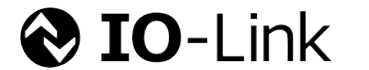

Wash-down work lights

- Very high luminous intensity
- Absolutely water tight thanks to protection class IP68/69K
- Withstands aggressive cleaning processes in the food industry



Compact tower lights

- Easily mounted and aligned (e.g. M12 connector)
- Versions with and without acoustic alarm (adjustable, max. 95 dB)
- Green, yellow, red, blue or white LEDs
- Excellent luminosity, good visible even at greater distances



RFID system BL ident®

- Flexibly integrated in systems, thanks to the modular concept of the I/O systems BL67, BL20
- Many application possibilities thanks to mixed HF and UHF operation
- Data carriers and read/write heads in IP69K, made of food-safe materials

